

1. Marking method

Laser Marking or Ink Marking.

2. Marking

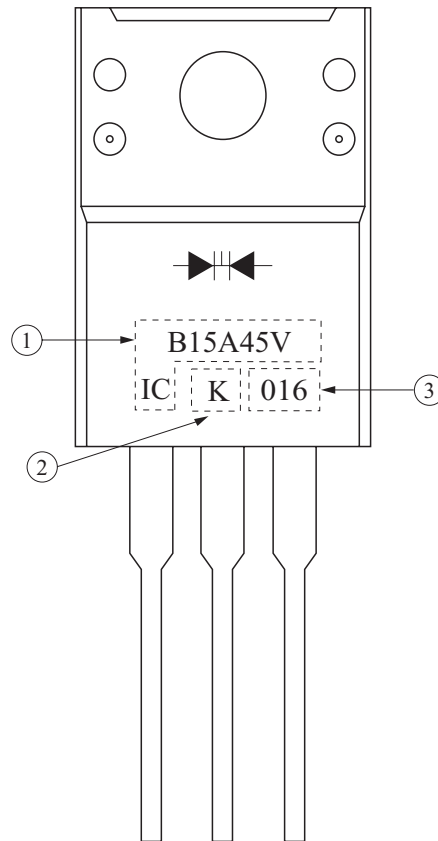

No.	Item	Marking	Description		
①	Device Name	B15A45VIC	B15A45VIC		
②	KEC	K	KEC CORP.		
③	Lot No.	016	0	Year	0~9 : 2000~2009
			16	Week	16 : 16th Week